

LAC i | Laboratori d'Arquitectura Computacional I
LAC ii | Laboratori d'Arquitectura Computacional II

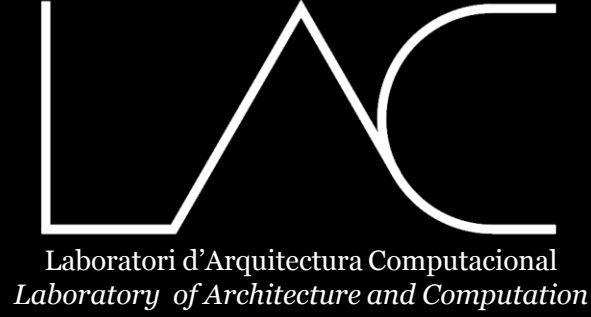

ETSAB 22-23
1er – 2on Quadrimestre

Disseny Computacional
Fabricació Digital

LAC ii | Laboratori d'Arquitectura Computacional II
LAC ii | *Laboratory of Architecture and Computation II*

LAC ii
ETSAB 22-23
2on Quadrimestre

ETSAB 22-23
2on Quadrimestre

Fabricació Digital
Digital Fabrication

LAC ii | *Laboratori d'Arquitectura Computacional II*

Experimentació en disseny computacional i fabricació digital orientats al projecte arquitectònic

El curs transitarà del Disseny Computacional a la Fabricació Digital, de l'experimentació al prototipat del projecte, fins a la construcció d'un espai a escala 1:1.

Taller i Coordinació – Carles Sala + Relja Ferusic (DPA)

Mediació – Antoni Ortí (DTA)

Seminari – Lluís Giménez-Mateu (DRA) + Salvador Gilabert (DRA)

Àrea AE – Sistemes Tecnològics | Eines de Disseny i Producció Digital

Taller 2Q – Fabricació Digital i Construcció de Sistemes d'Agregació i Estructures Lleugeres

Seminari 2Q – SDF | Sistemes Digitals de Fabricació

Outcomes Projectes – Presentacions, Publicacions, Prototipat i Construcció 1:1

Col.laboracions – CIM i Ateneus de Fabricació

Llengües vehiculars – Anglès | Català | Castellà

Què?

Gaudí (1852 – 1926)



Fuller (1895 – 1983)

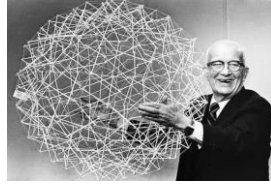

Otto (1925 – 2015)



Informació

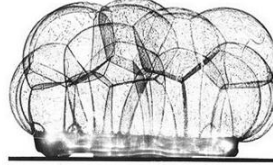
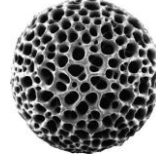
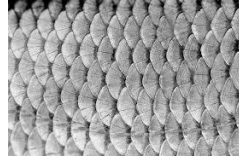

Computació

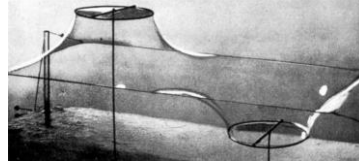
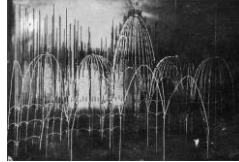

Fabricació



Fabricació Digital
Digital Fabrication

ETSAB 22-23
2on Quadrimestre

Qui?

Carles Sala

Architect MArch

Professor Associat DPA

Carles Sala és arquitecte MArch registrat al COAC i membre de l'AA Architectural Association de Londres. Es va graduar a l'ETSAB-UPC a Barcelona i posteriorment va obtenir un màster a l'AA School of Architecture' AADRL de Londres, amb una beca de la Fundació 'La Caixa'. És fundador de l'estudi SALA FERUSIC Architects de Barcelona.

A nivell docent ha impartit classes de projectes arquitectònics a la WSA Cardiff (2014-2017) i va codirigir un Seminari al Màster en Arquitectura Avançada de l'IAAC a Barcelona (2018-2019). Des de 2017 és professor associat de projectes arquitectònics a l'ETSAB de Barcelona i des de 2013 és codirector del grup de recerca "Bodega" de l'AA School of Architecture.

Lluís Giménez-Mateu

Architect

Professor Cap de Departament DRA

Lluís Giménez és Doctor Arquitecte a l'ETSAB-UPC a Barcelona. És director del Departament de Representació Arquitectònica de la UPC - Barcelona Tech.

És professor de Geometria Descriptiva a l'ETSAB des del 2003, ha participat també al "Màster en Disseny i Comunicació Visual", "Paisatge Màster - MBLandArch" i "Grau de Multimèdia i Videojocs" a la CITM School de FPC.

Ha col·laborat amb la Universitat d'Arquitectura i Desenvolupament Urbà Ion Mincu de Bucarest (Romania) i l'Escola d'Arquitectura de la Universitat de Tianjin (Xina). També és membre del grup ADR & M Research.

Relja Ferusic

Architect MSc

Professor Associat DPA

Relja Ferusic és arquitecte MSc registrat a COAC, AABiH i REG a Suïssa. Es va graduar a l'ETSAB-UPC a Barcelona, on més tard va obtenir un màster amb el tema "hibridació de l'espai urbà i xarxes socials digitals". És fundador de l'estudi SALA FERUSIC Architects a Barcelona.

A nivell docent, ha impartit classes de projectes arquitectònics a D-Arch ETH a Zurich (2005-2007), a l'ESARQ UIC (2008-2009), a Barcelona, així com va codirigir un Seminari al Màster en Arquitectura Avançada de l'IAAC a Barcelona (2018-2019). Des de 2015 és professor associat de projectes arquitectònics a l'ETSAB de Barcelona i des de 2013 és codirector del grup de recerca "Bodega" de l'AA School of Architecture.

Toni Ortí

Architect

Professor Associat DTA - Estructures

Professor Associat Departament de Tecnologia en l'Arquitectura, àmbit d' Estructures Arquitectòniques ETSAB (des de 2002), i soci de BAC Engineering Consultancy Group.

A nivell docent s'ha centrat en la especialització d'estructures, a escoles com l'Escola d'Arquitectura La Salle, l'Escola Elisava i com a ponent a diferents màsters de la Fundació UPC, entre altres. La seva activitat d'investigació s'ha vinculat al desenvolupament d'eines BIM i el estudi de materials avançats com projecte Auto-BIM, Air-Bridge, i AGE Anàlisis d'estructures pel mètode dels elements finits, entre d'altres.

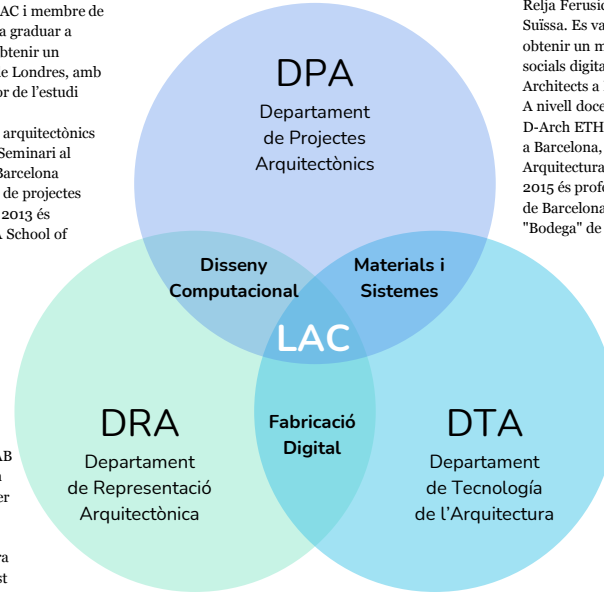

ETSAB Escola Tècnica Superior d'Arquitectura de Barcelona



Com?

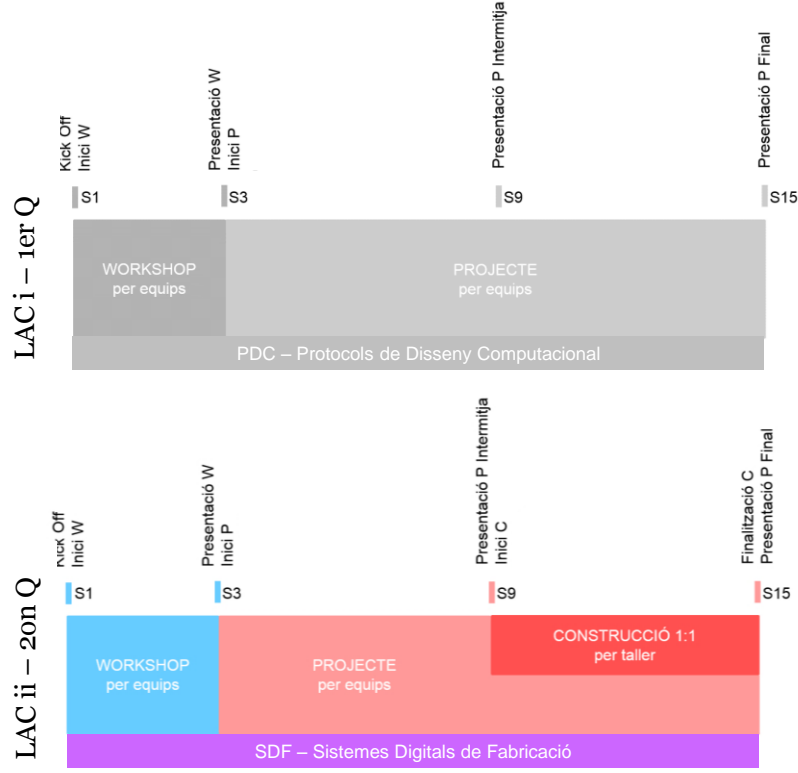

#exploració



#experimentació



#eina

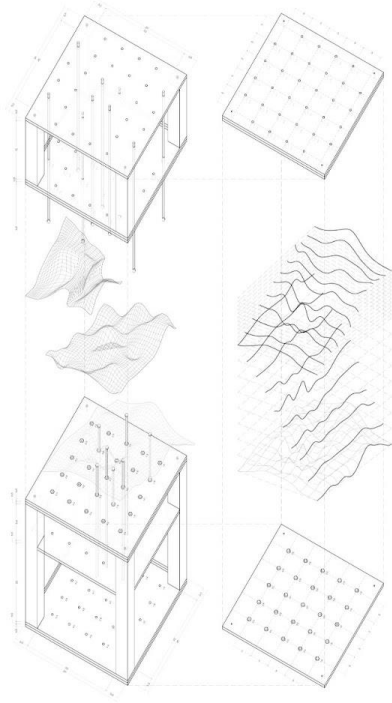

#utillatge

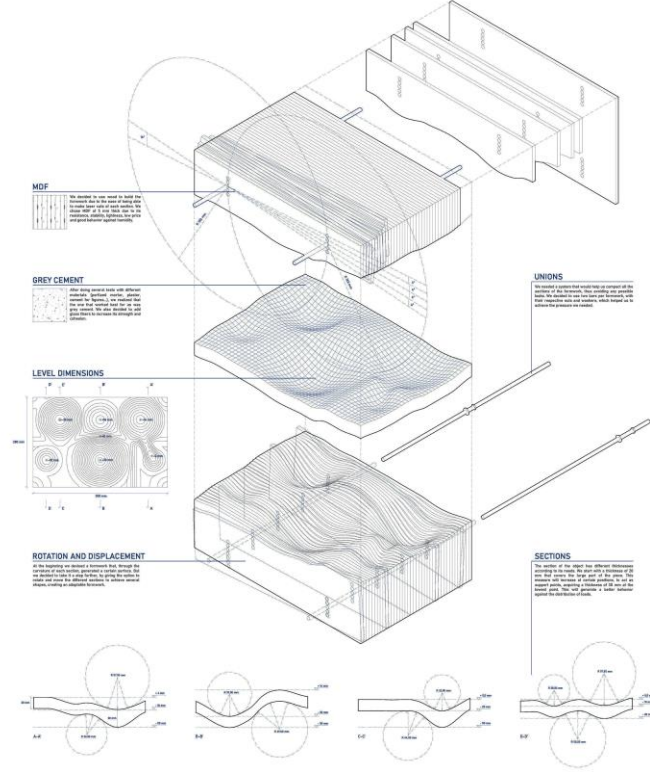

#màquina

RE-USE RO-STATION

Humans over time have had elements that accompany us at home and in life. Many remain that explain how people lived in ancient times and what way of life they led were the vases and plates. Our material that we want to use is one that recreates this historical journey like mud and clay, but in a different way. From the extrusion of the mud, and giving it a section, we have created an element that has movement in one direction and gives it rotation, thus creating that the section that comes out of the extruder machine can also rotate and give it movement when it comes out. With this method we can create different sections and each vase can be different from the previous one since by rotating and moving our disk you can create unique objects different from all the others created. When dry, this item stands up on any way you like and each item can have a different use.

Biel Bayés - Miquel Bravo - Àlvaro Cercós

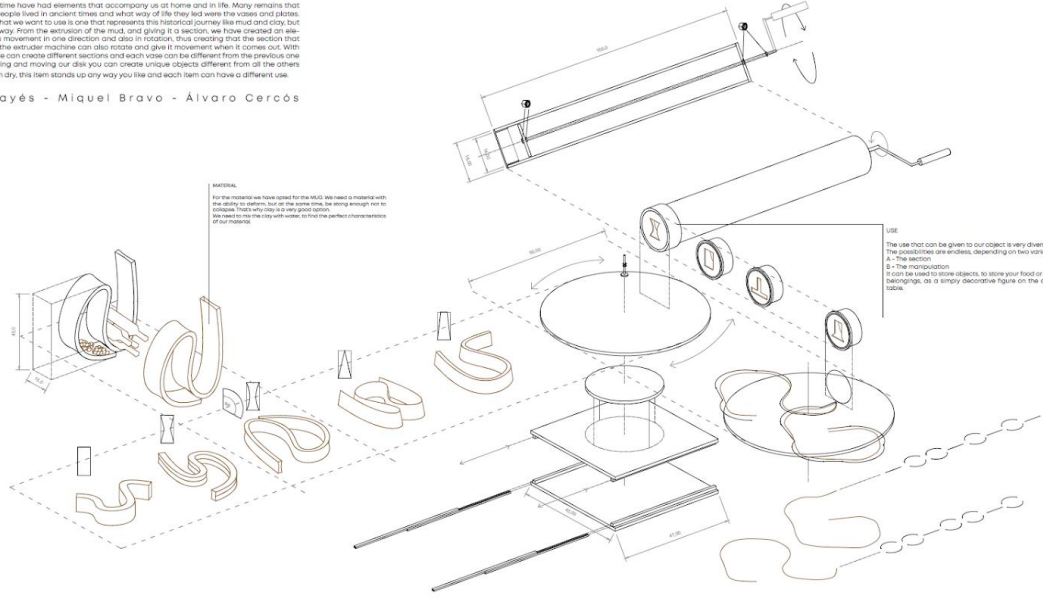

#fabricació



#procés

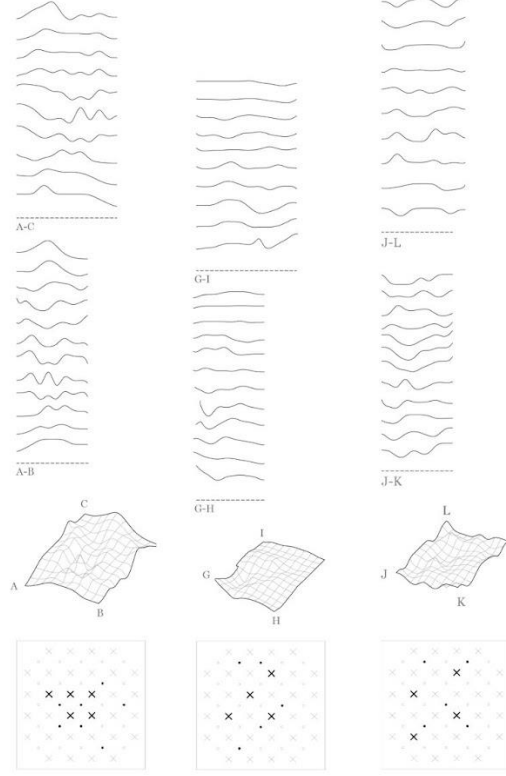

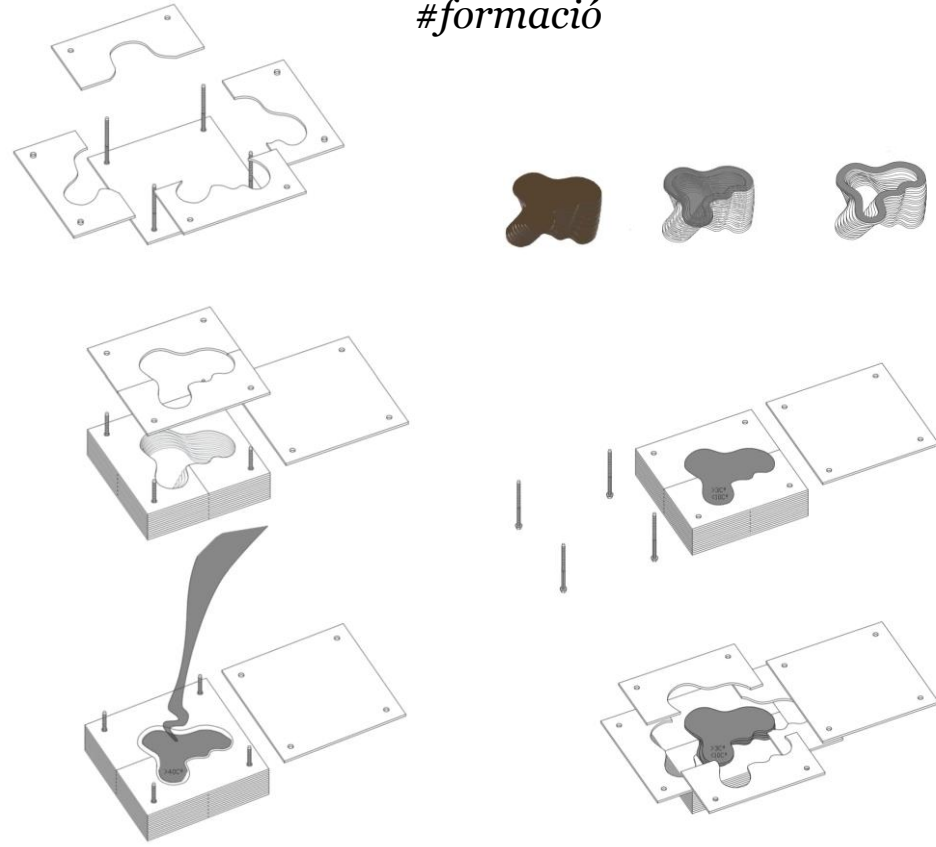

#manufactura

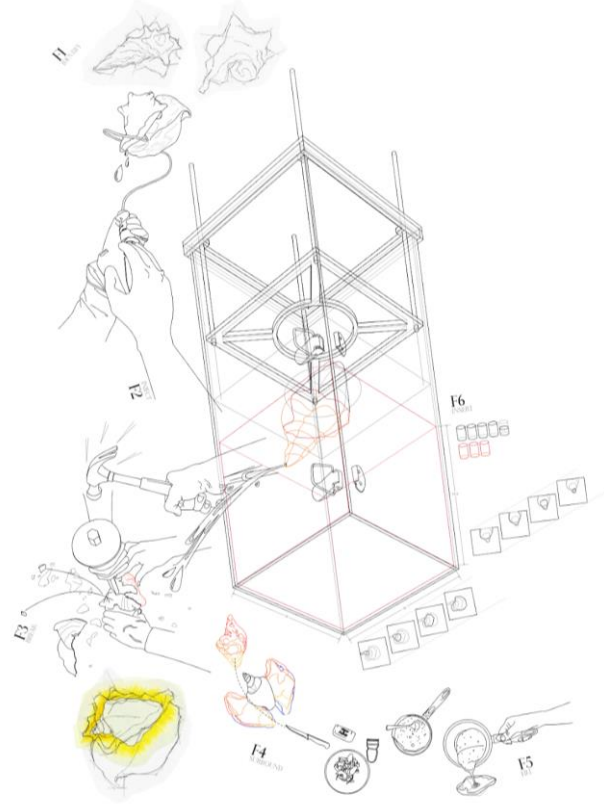

#tècnica



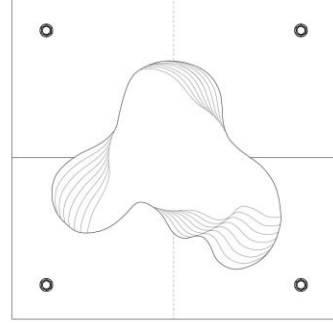
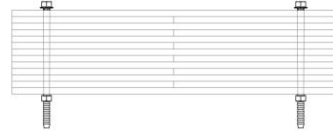

#emmotllat

#seccionament

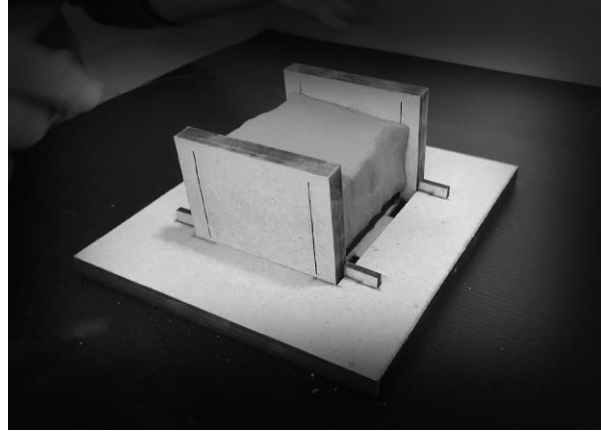

#termoformat



#material

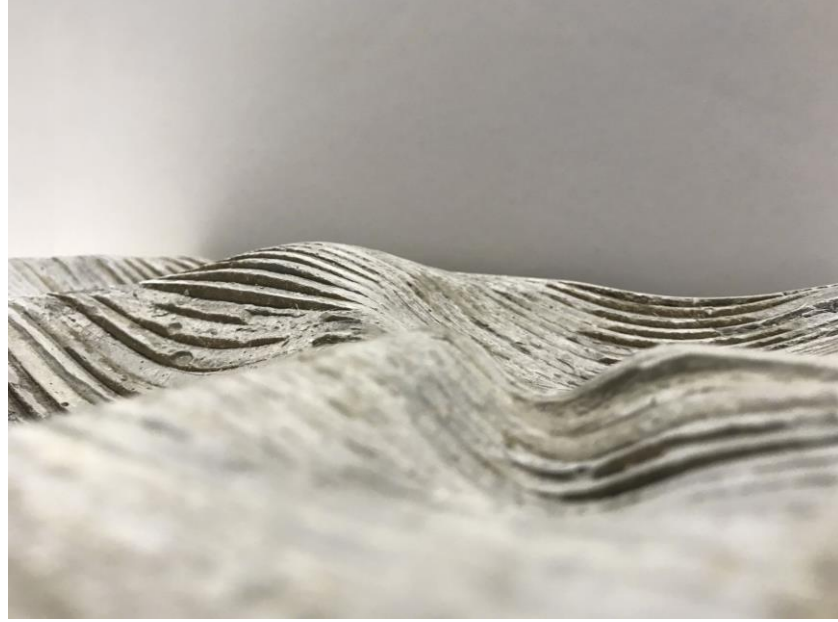

#continuu

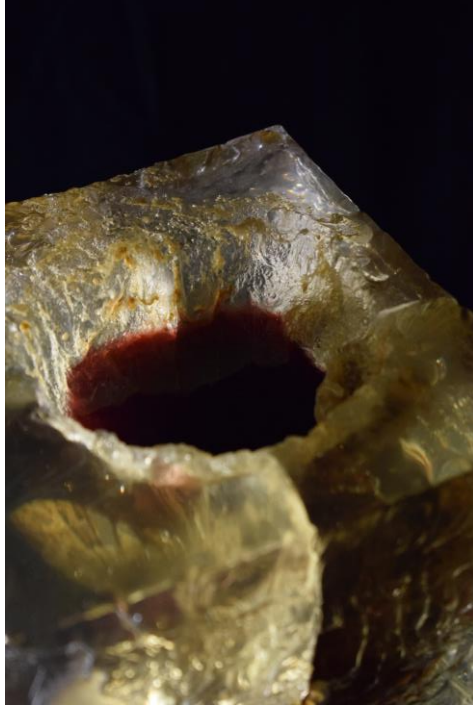

#discret



#encofrat



#plegat



#format



LAC ii | Laboratori d'Arquitectura Computacional II
LAC ii | *Laboratory of Architecture and Computation II*

#projecte

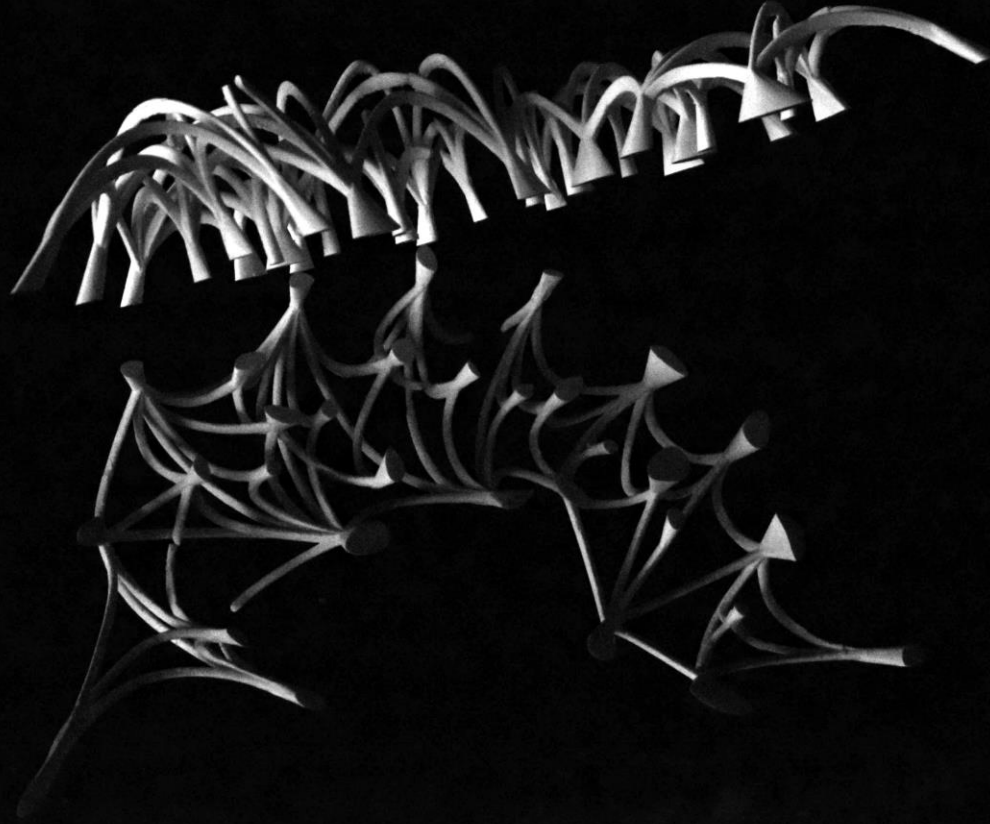

ETSAB 22-23
2on Quadrimestre

Fabricació Digital
Digital Fabrication

LAC ii | Laboratori d'Arquitectura Computacional II
LAC ii | Laboratory of Architecture and Computation II



#fabricació digital



Fabricació Digital
Digital Fabrication

ETSAB 22-23
2on Quadrimestre

#material



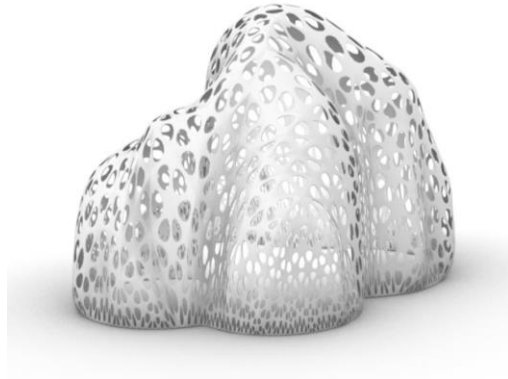

#geometria

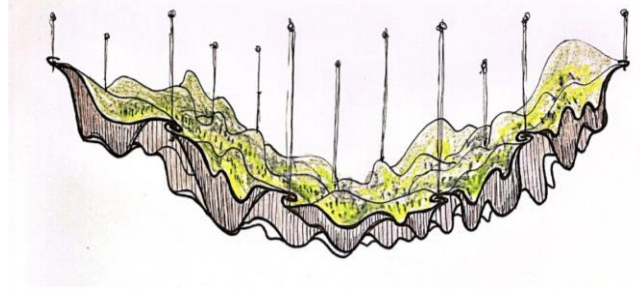

#in-formació

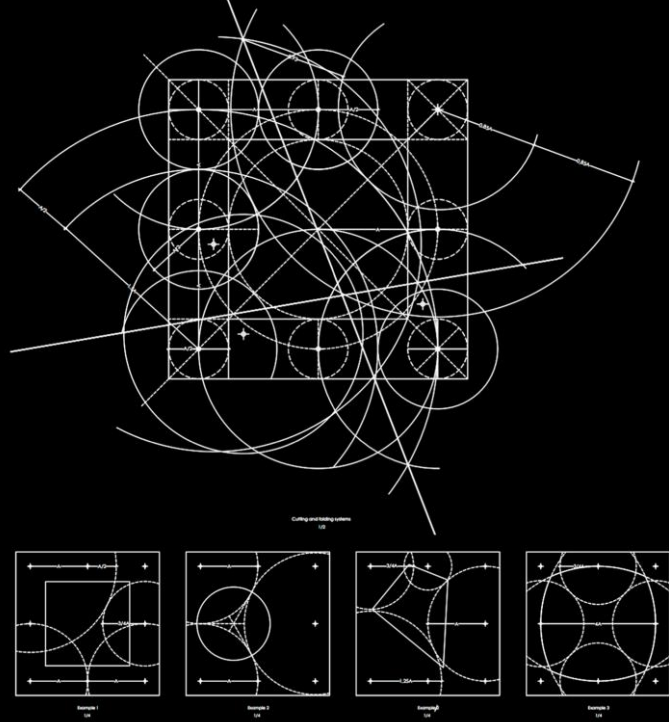

#formació

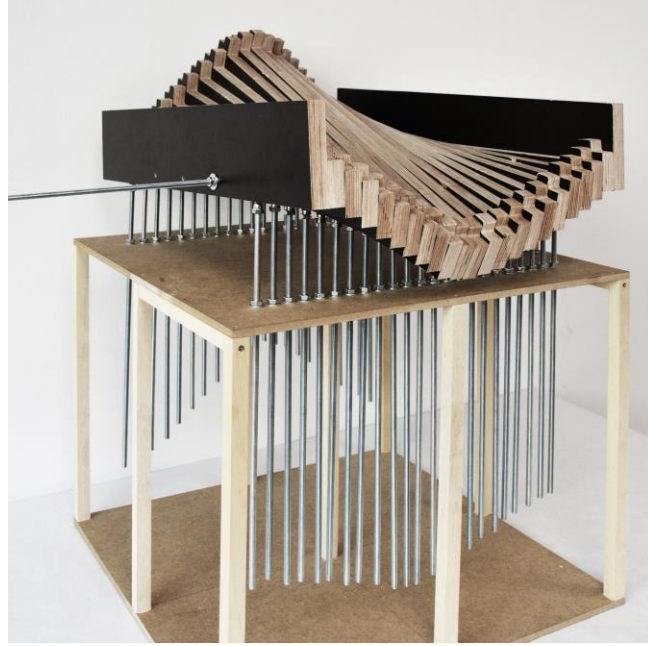

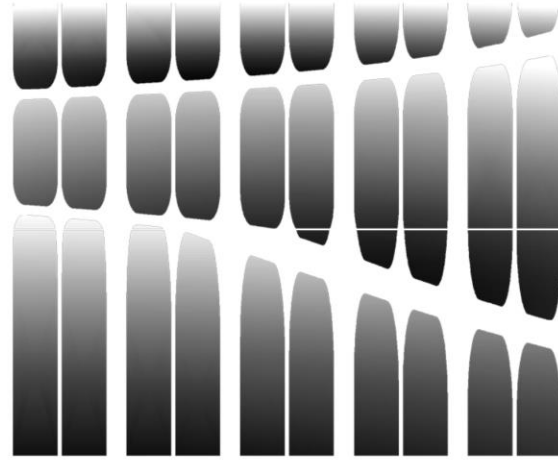

#unitat

#sistema

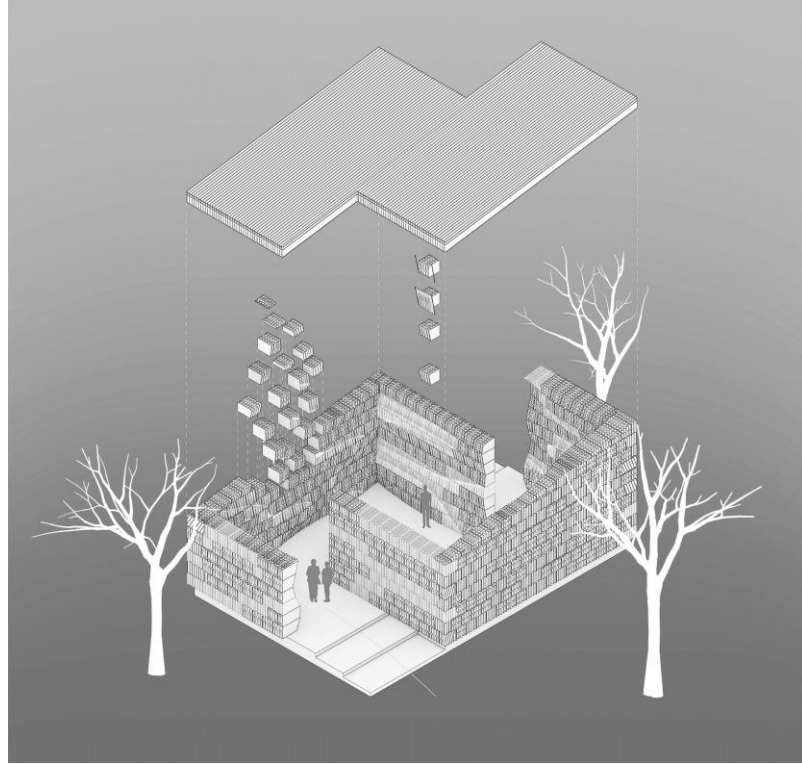

#brick

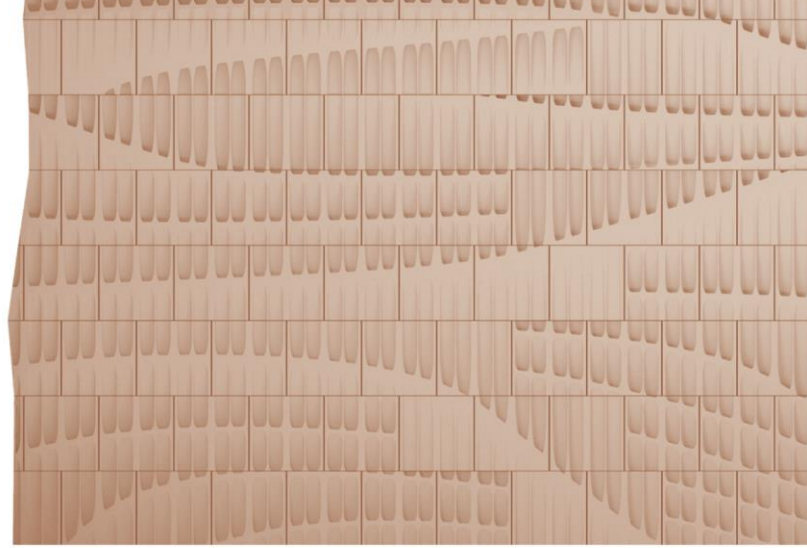

#component-based

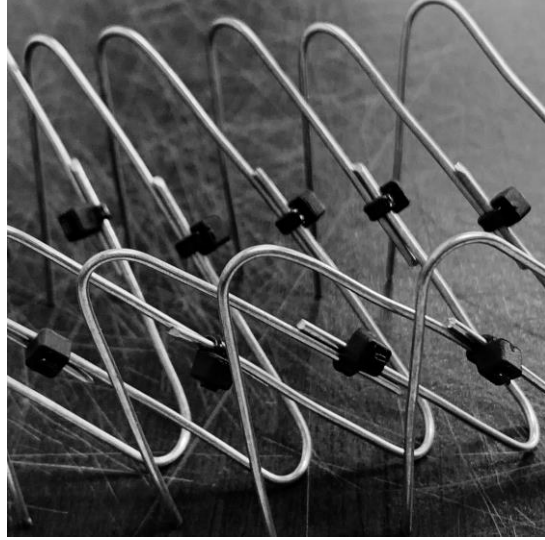

#impressió 3D



#narrativa

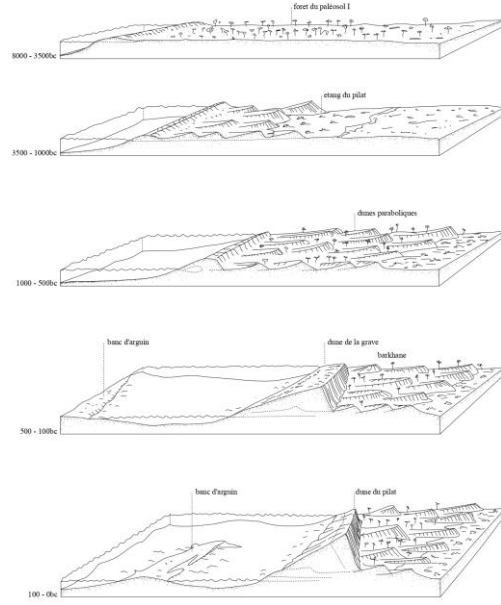

evolució formació Dune

#col.laboració

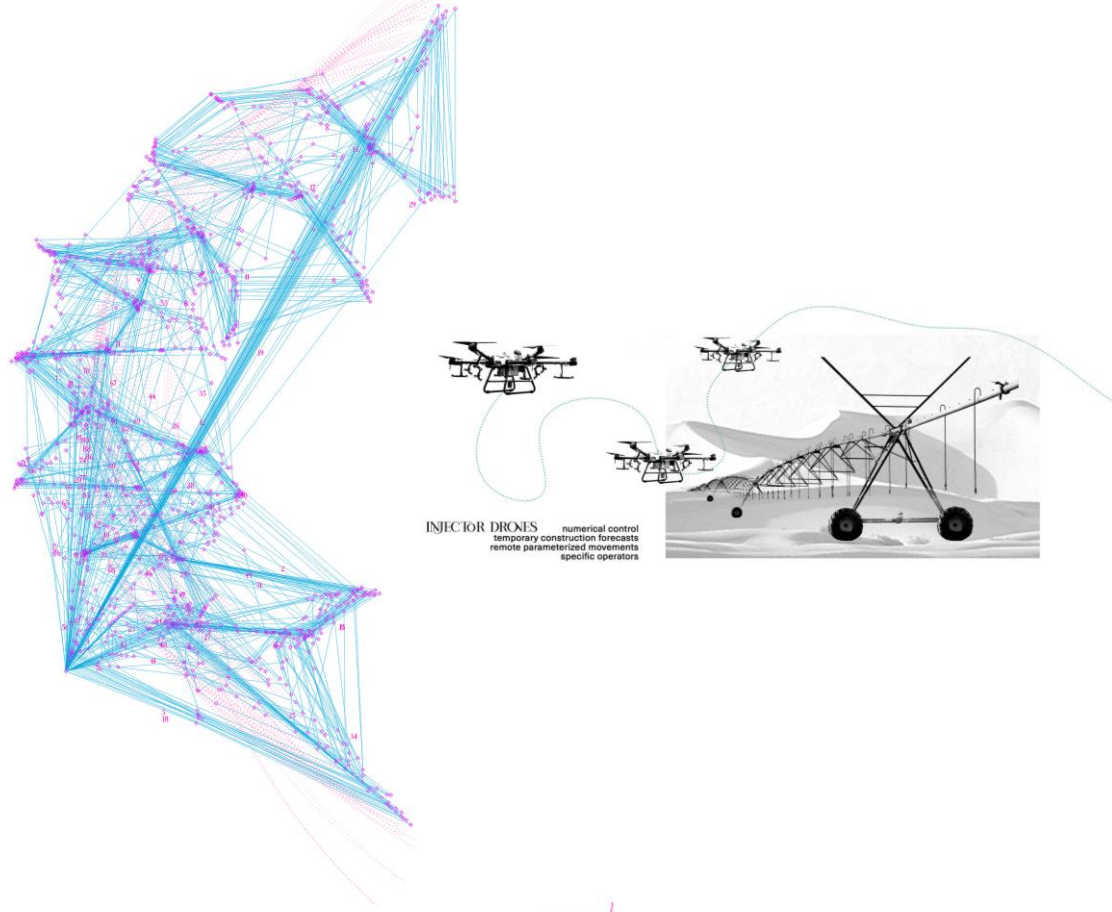

#entorn



#procés

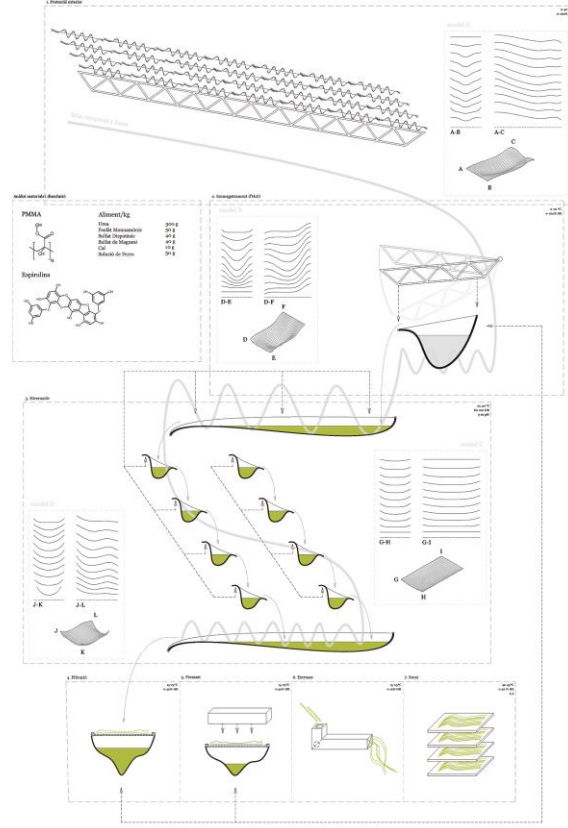

#simulació

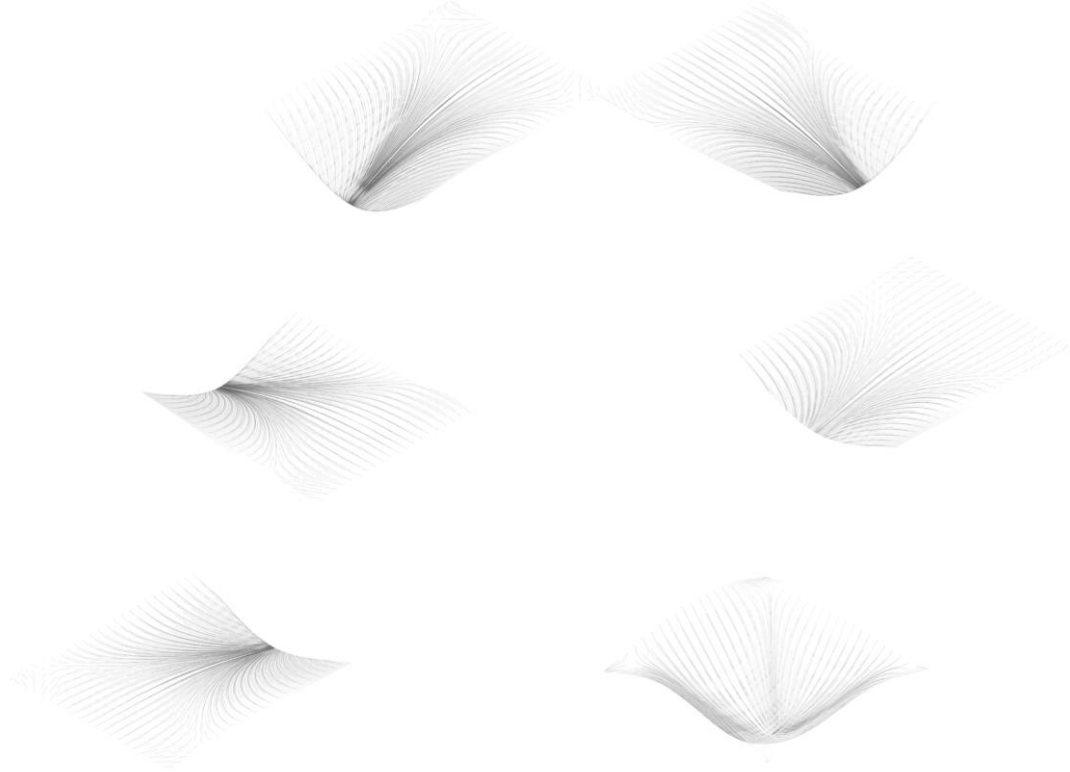

LAC ii | Laboratori d'Arquitectura Computacional II
LAC ii | *Laboratory of Architecture and Computation II*

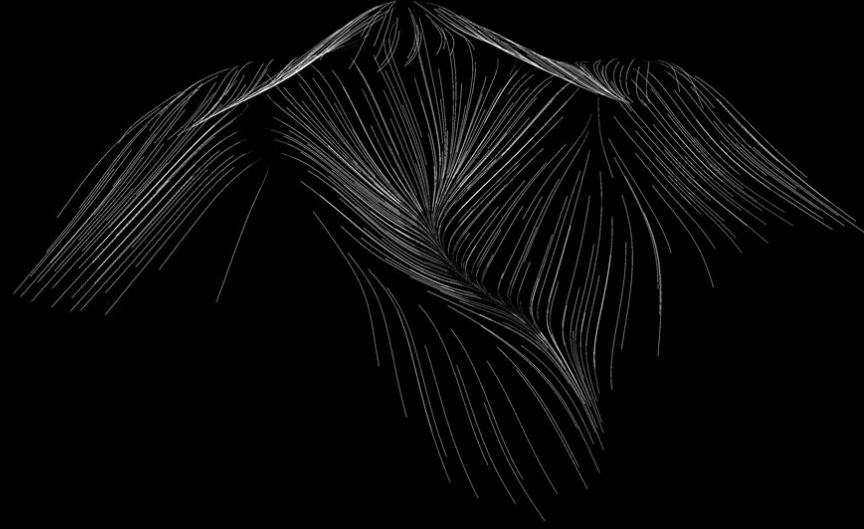

#agents

ETSAB 22-23
1er Quadrimestre

Disseny Computacional
Computational Design

LAC ii | Laboratori d'Arquitectura Computacional II
LAC ii | *Laboratory of Architecture and Computation II*

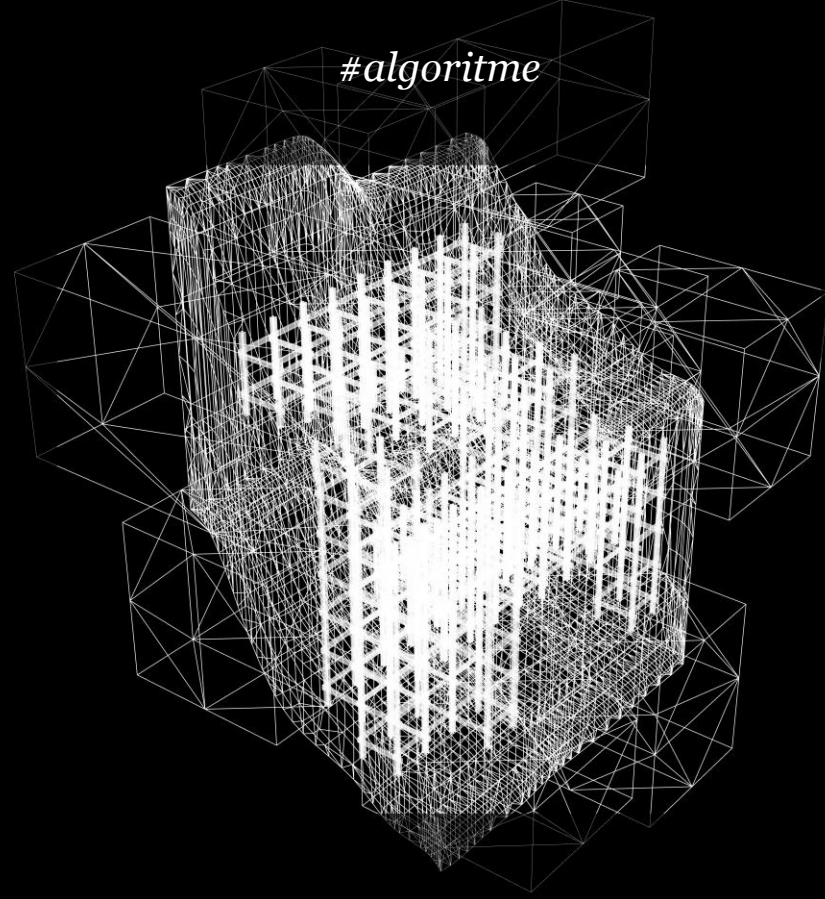

ETSAB 22-23
1er Quadrimestre

Disseny Computacional
Computational Design

LAC ii | Laboratori d'Arquitectura Computacional II
LAC ii | *Laboratory of Architecture and Computation II*

#computació

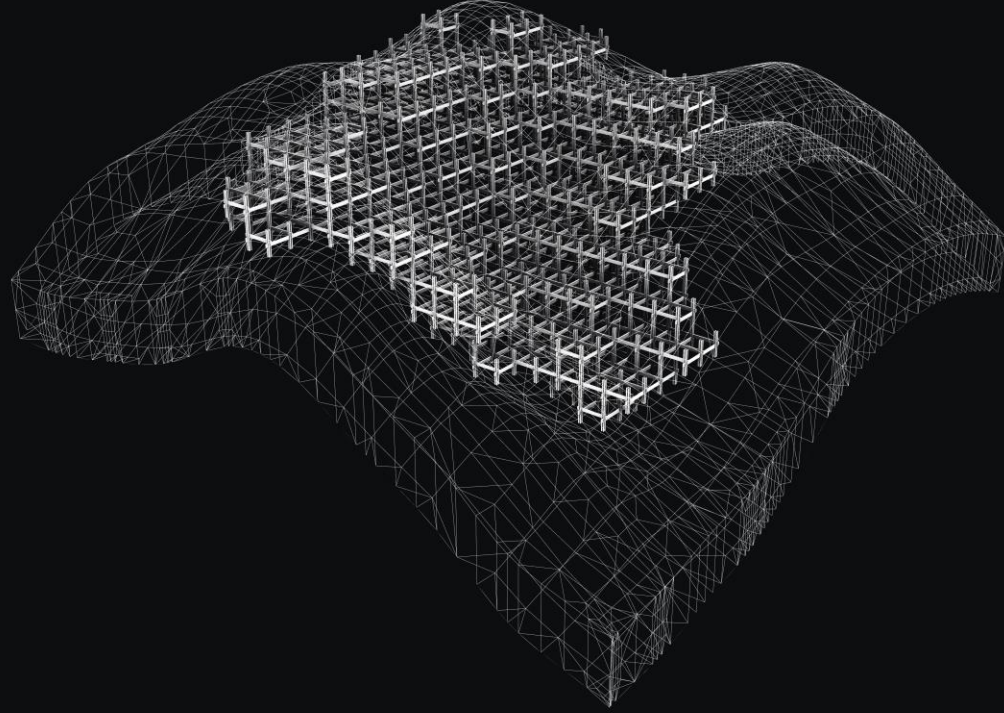

ETSAB 22-23
1er Quadrimestre

Disseny Computacional
Computational Design

LAC ii | Laboratori d'Arquitectura
LAC ii | *Laboratory of*

Arquitectura
Arquitectura

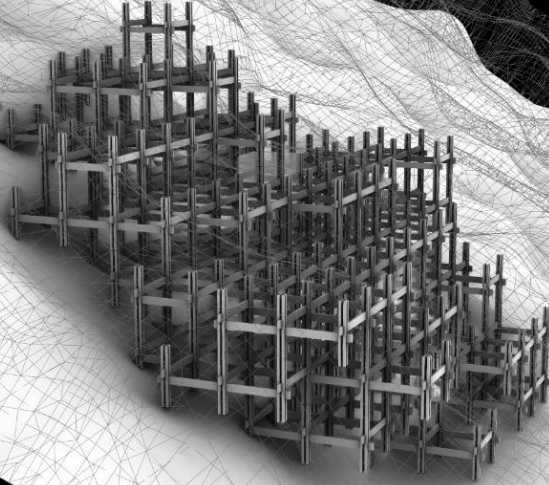

#model

ETSAB 22-23
1er Quadrimestre

Disseny Computacional
Computational Design

LAC ii | Laboratori d'Arquitectura Computacional II
LAC ii | *Laboratory of Architecture and Computation II*



#maqueta



ETSAB 22-23
2on Quadrimestre

Fabricació Digital
Digital Fabrication

#anàlisi

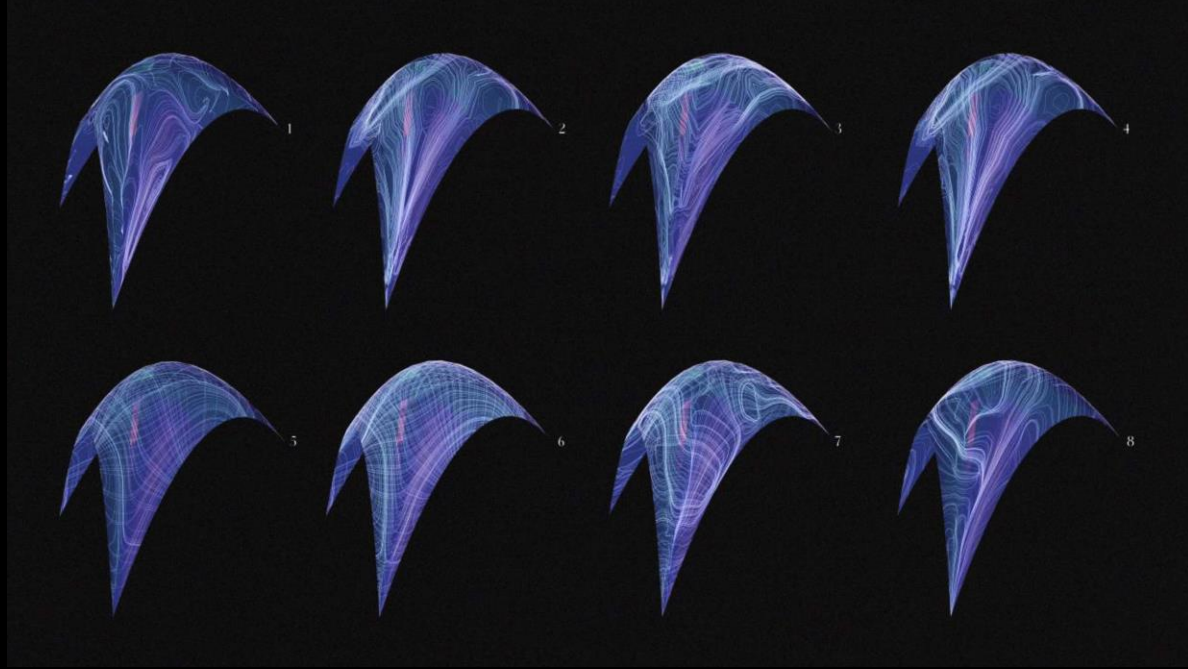

#estudi

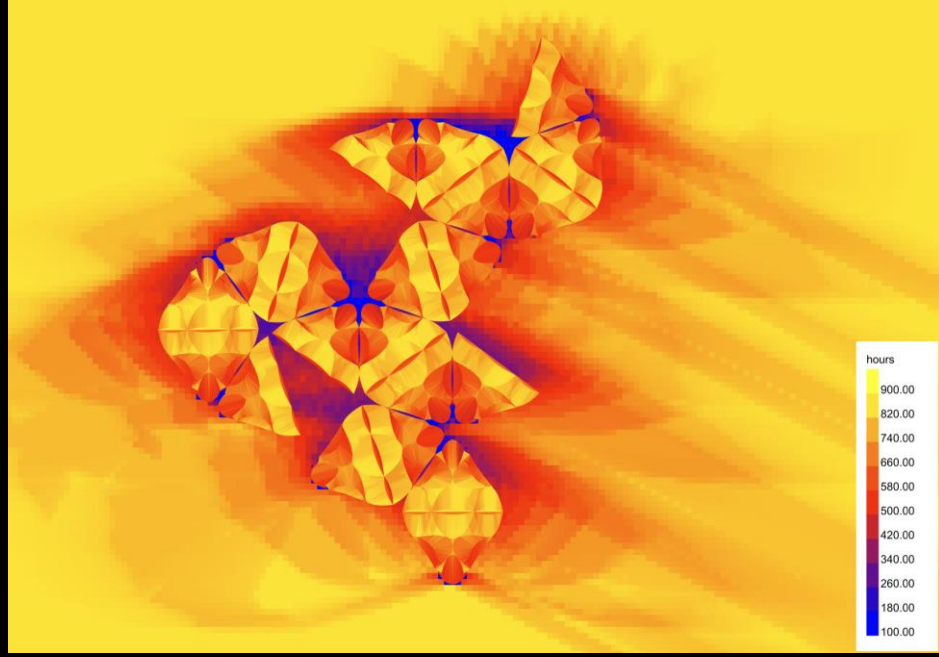

LAC ii | Laboratori d'Arquitectura Computacional II
LAC ii | *Laboratory of Architecture and Computation II*

#tesselació



ETSAB 22-23
2on Quadrimestre

Fabricació Digital
Digital Fabrication

LAC II | Laboratori d'Arquitectura Computacional II
LAC II | *Laboratory of Architecture and Computation II*

#especejament

ETSAB/22-23
1er Quadrimestre

Disseny Computacional
Computational Design

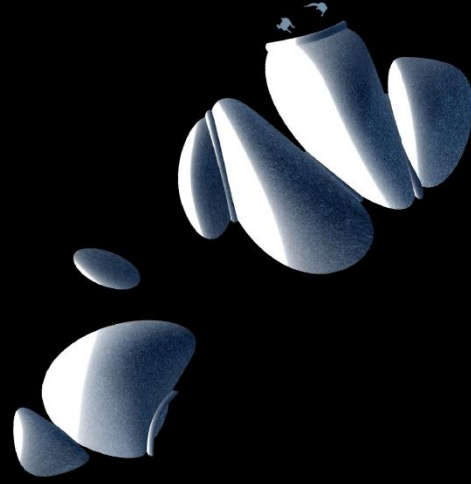

#temps

LAC ii | Laboratori d'Arquitectura Computacional II
LAC ii | *Laboratory of Architecture and Computation II*

#temps

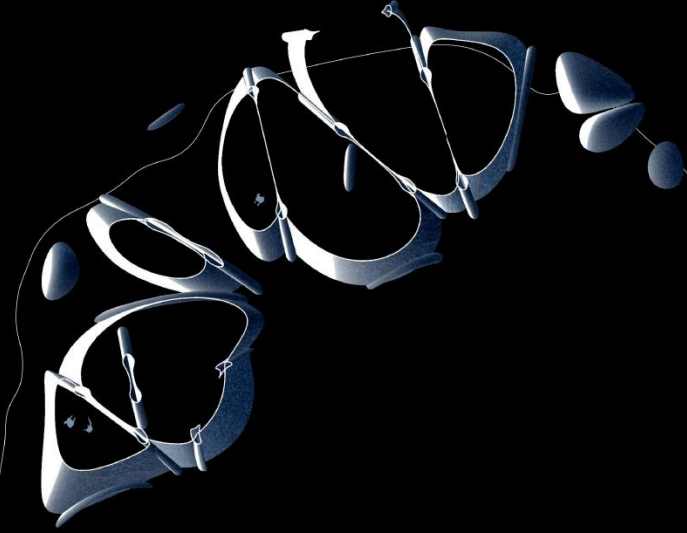

ETSAB 22-23
1er Quadrimestre

Disseny Computacional
Computational Design

15M

LAC ii | Laboratori d'Arquitectura Computacional II
LAC ii | *Laboratory of Architecture and Computation II*

#temps

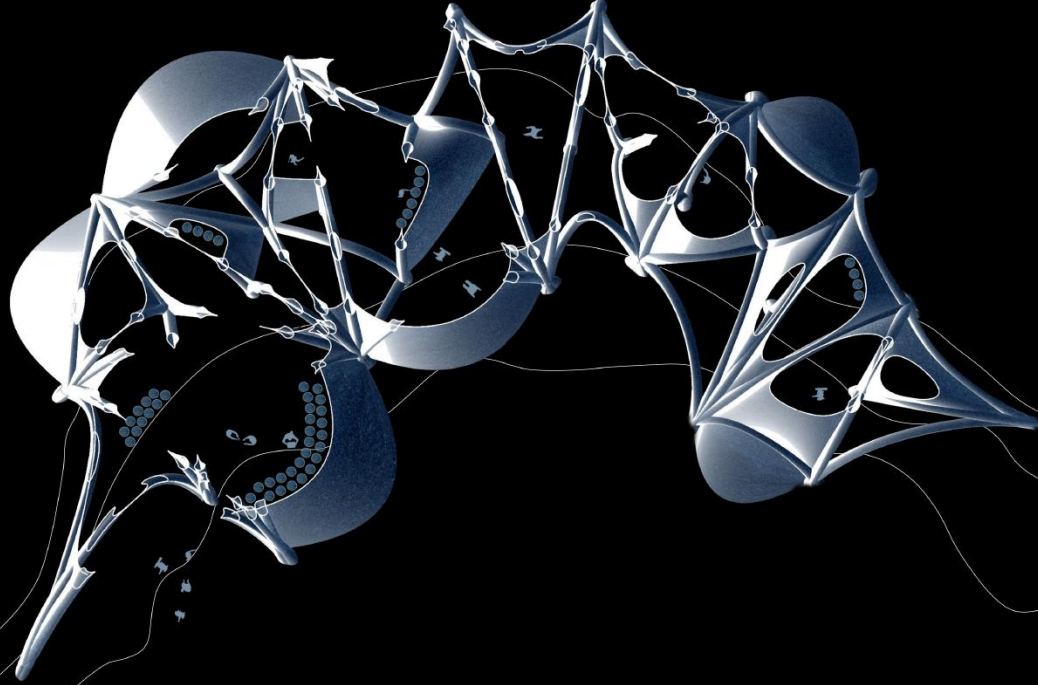

ETSAB 22-23
1er Quadrimestre

Disseny Computacional
Computational Design

15M

LAC ii | Laboratori d'Arquitectura Computacional II
LAC ii | *Laboratory of Architecture and Computation II*

#temps

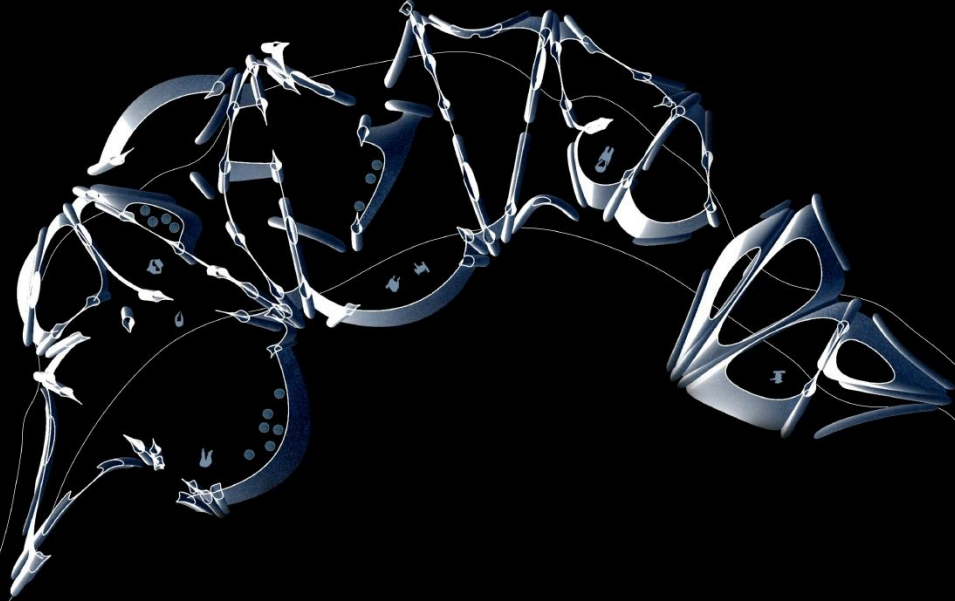

ETSAB 22-23
1er Quadrimestre

Disseny Computacional
Computational Design

15M

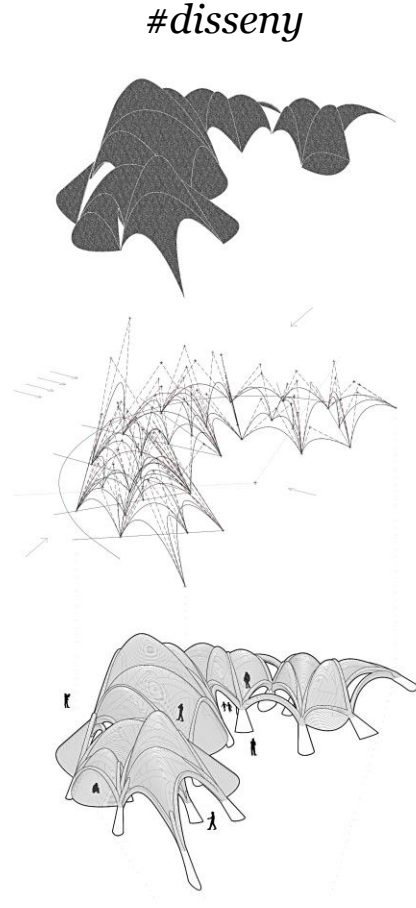

#fabricació

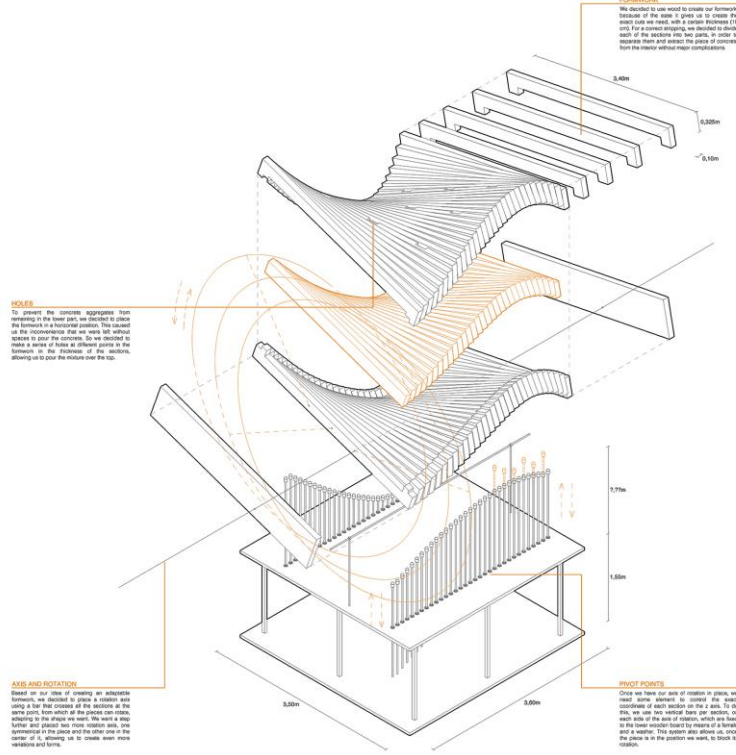

#mock up



#prototip



#construcció

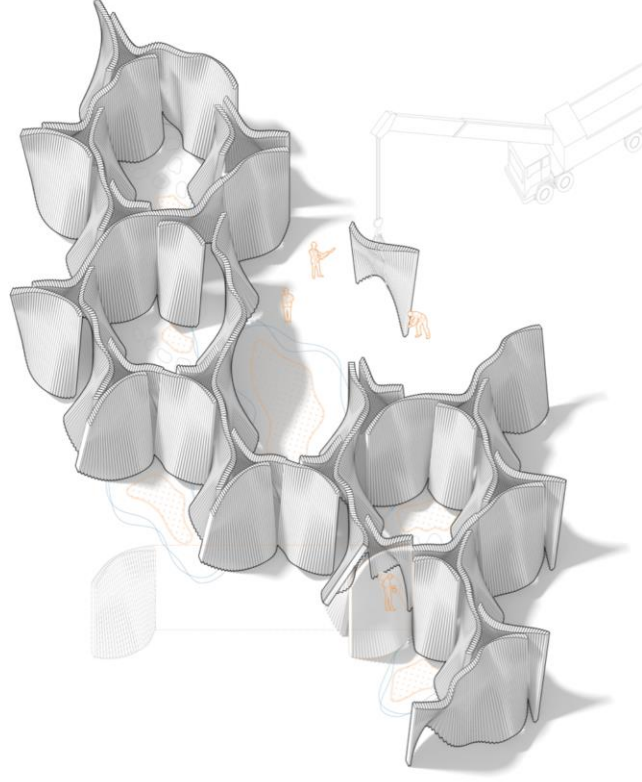

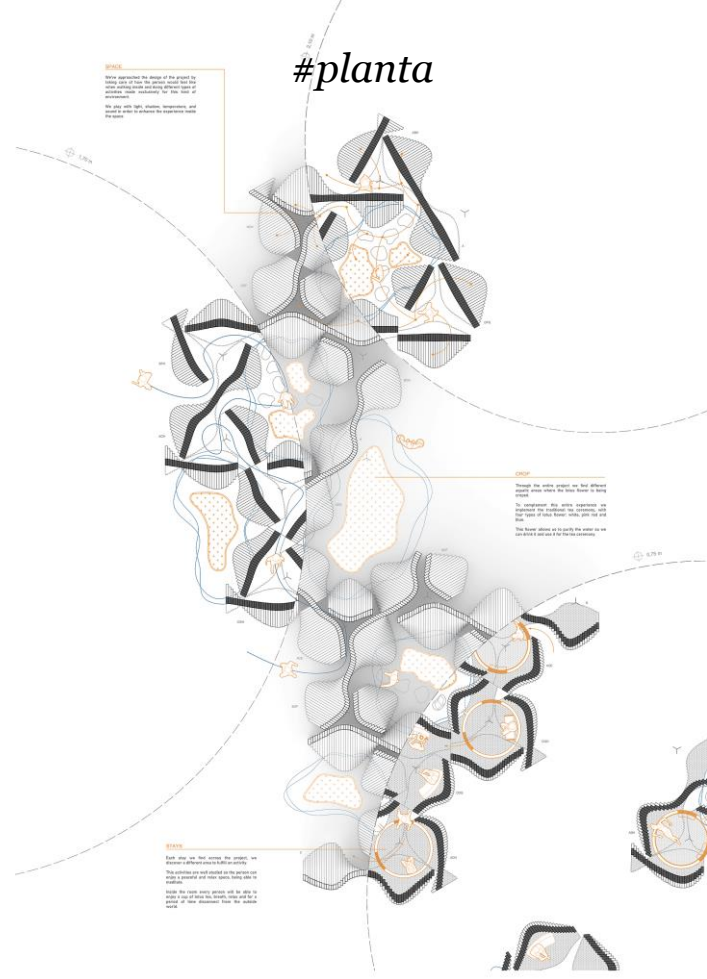

#grid

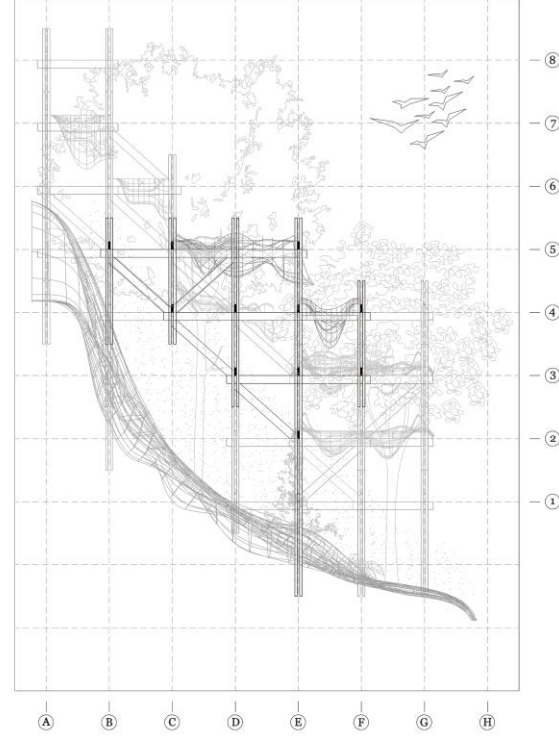

#secció

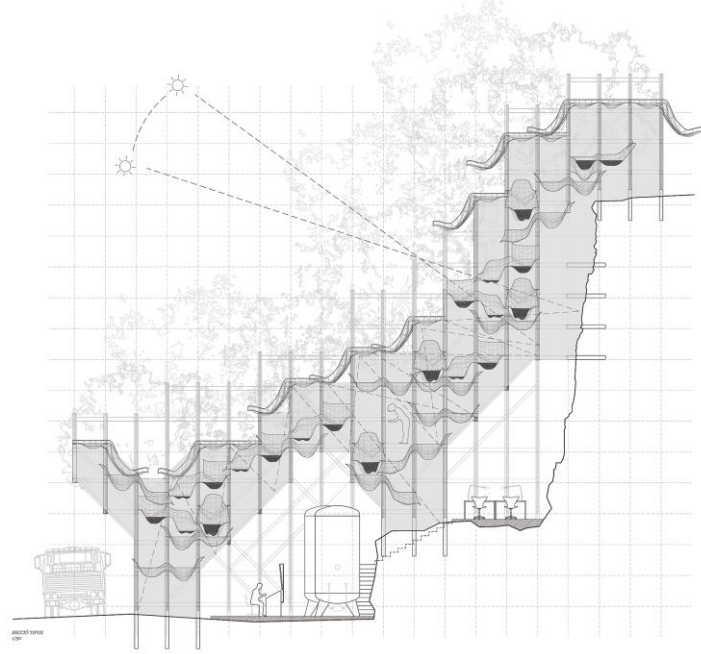

#axonometria

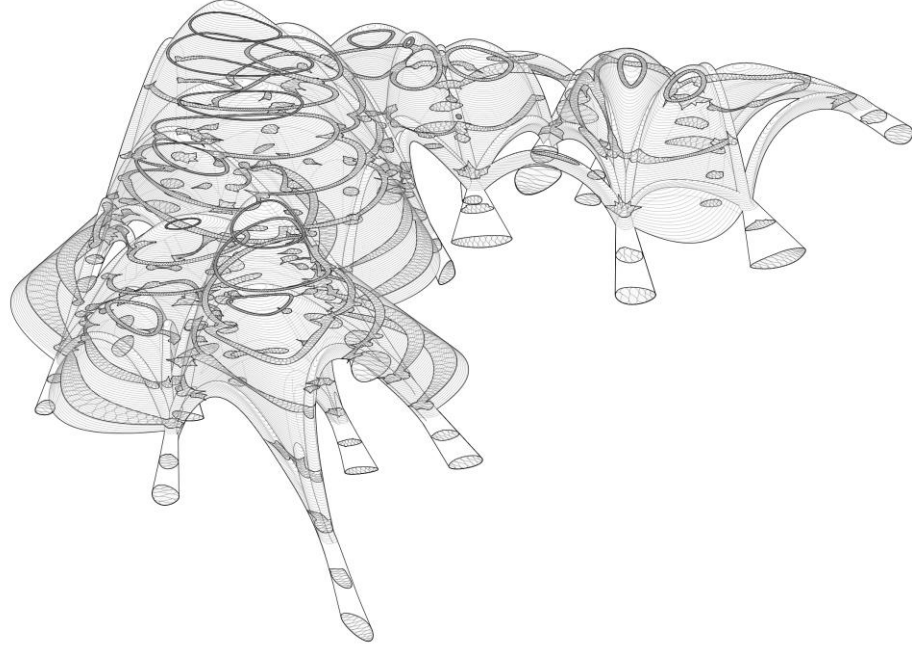

LAC ii | Laboratori d'Arquitectura Computacional II
LAC ii | *Laboratory of Architecture and Computation II*

#composició

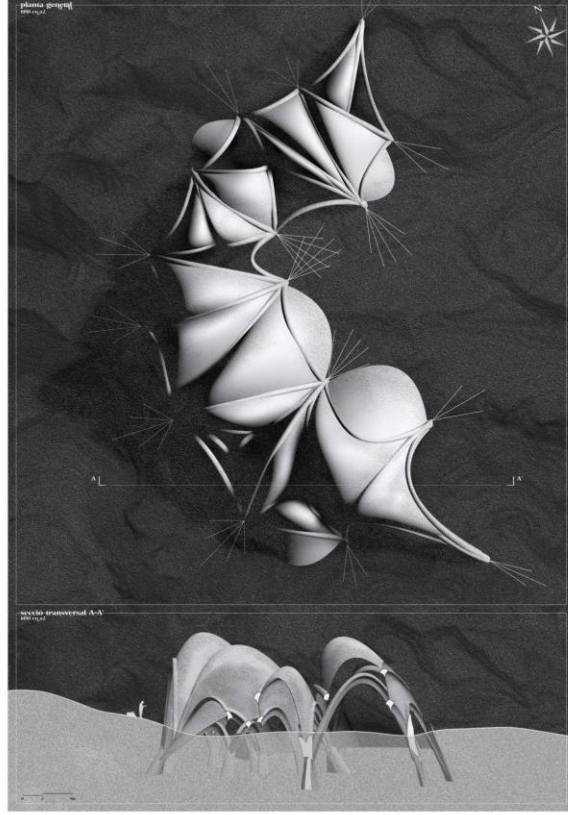

ETSAB 22-23
1er Quadrimestre

Disseny Computacional
Computational Design

#visualització

LAC II | Laboratori d'Arquitectura Computacional II
LAC II | Laboratory of Architecture and Computation II

Disseny Computacional
Computational Design

ETSAB 22-23
1er Quadrimestre



LAC ii | Laboratori d'Arquitectura Computacional II
LAC ii | *Laboratory of Architecture and Computation II*

#collage



ETSAB 22-23
1er Quadrimestre

Disseny Computacional
Computational Design

LAC ii | Laboratori d'Arquitectura Computacional II
LAC ii | *Laboratory of Architecture and Computation II*

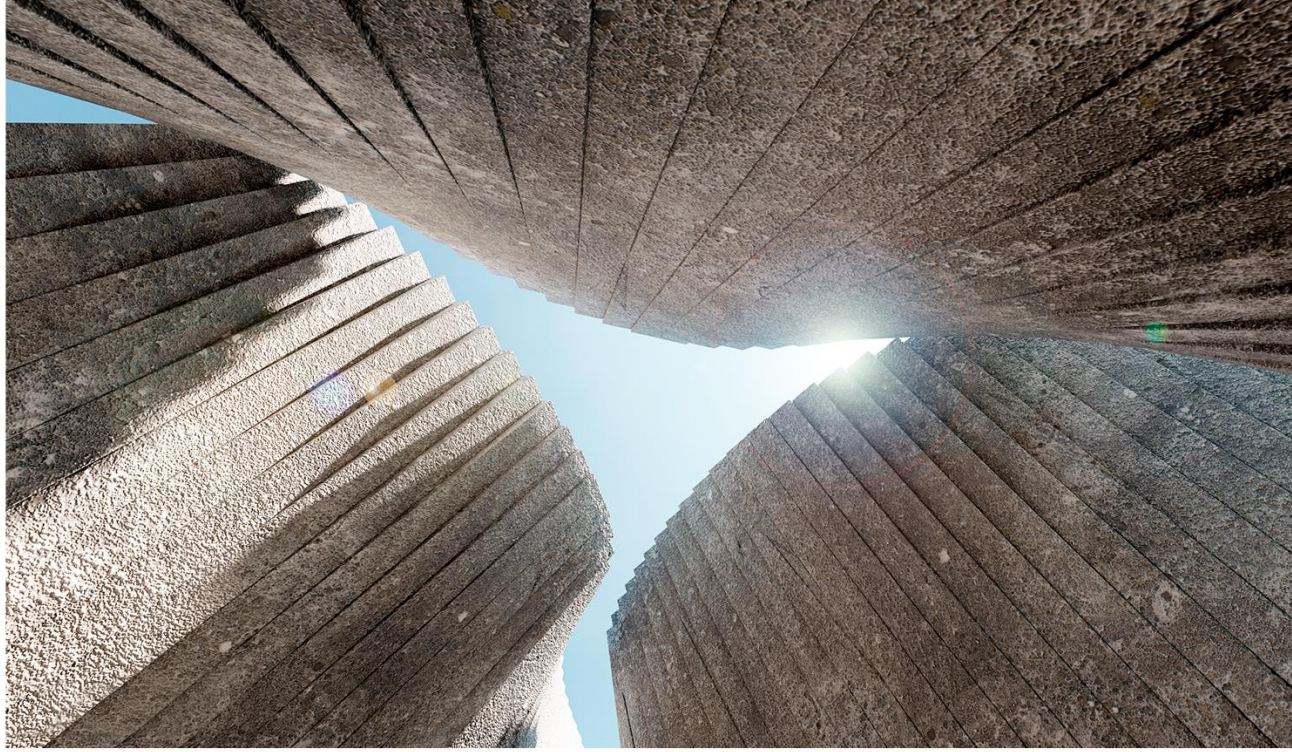

#espai

ETSAB 22-23
1er Quadrimestre

Disseny Computacional
Computational Design

LAC ii | Laboratori d'Arquitectura Computacional II
LAC ii | *Laboratory of Architecture and Computation II*

#ambient



ETSAB 22-23
1er Quadrimestre

Disseny Computacional
Computational Design

LAC ii | Laboratori d'Arquitectura Computacional II
LAC ii | *Laboratory of Architecture and Computation II*



#usuari

ETSAB 22-23
1er Quadrimestre

Disseny Computacional
Computational Design

#entorn



#arquitectura

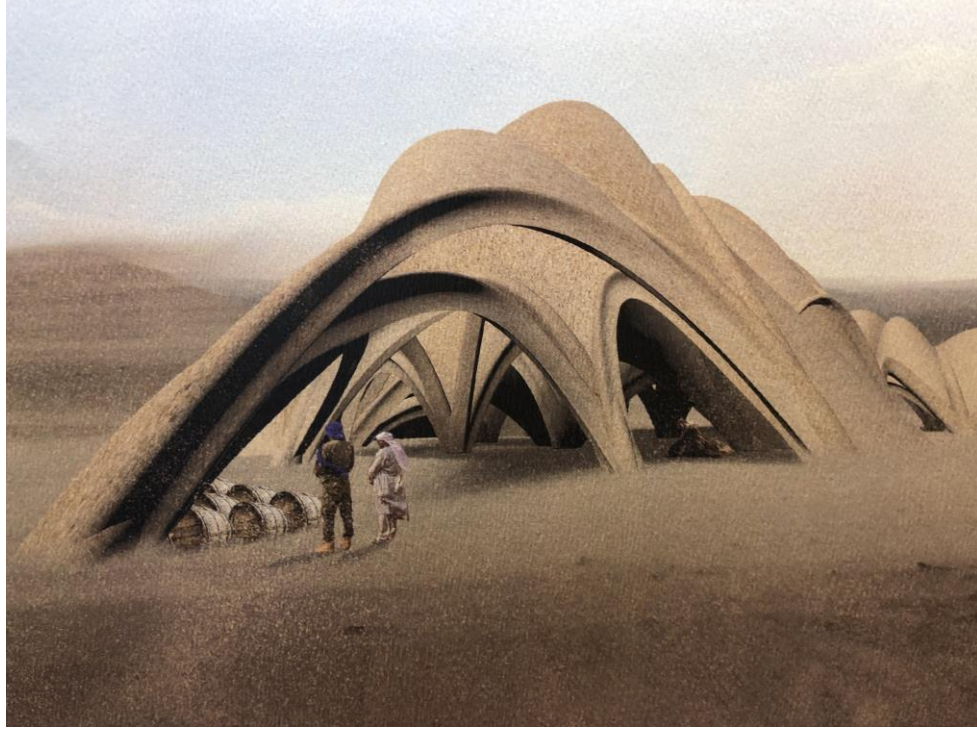

#construcció

LAC ii | Laboratori d'Arquitectura Computacional II
LAC ii | Laboratory of Architecture and Computation II



ETSAB 22-23
2on Quadrimestre

Fabricació Digital
Digital Fabrication



LAC ii | Laboratori d'Arquitectura Computacional II
LAC ii | Laboratory of Architecture and Computation II

#COAC

ETSAB 22-23
2onr Quadrimestre

Fabricació Digital
Digital Fabrication

Un edifici,
un arquitecte

Un edifici,
un arquitecte

Un edifici,
un arquitecte

Un edifici,
un arquitecte

#ateneus

LAC II | Laboratori d'Arquitectura Computacional II
LAC II | Laboratory of Architecture and Computation II



Fabricació Digital
Digital Fabrication

ET SAB 22-23
2on Quadrimestre



LAC ii | Laboratori d'Arquitectura Computacional II
LAC ii | Laboratory of Architecture and Computation II

#escoles



Fabricació Digital
Digital Fabrication



ETSAB 22-23
2on Quadrimestre

#performance

LA 211 | Laboratori d'Arquitectura Computacional II
EAC II | Laboratory of Architecture and Computation II



Fabricació Digital
Digital Fabrication

ETSAB 22-23
2on Quadrimestre

LAC ii | Laboratori d'Arquitectura i Computació
LAC ii | Laboratory of Architecture and Computation II



#participació



Fabricació Digital
Digital Fabrication

ETSAB 22-23
2on Quadrimestre

#SonallsDelSilenci

LACii | Laboratori d'Arquitectura Computacional II
LACii | Laboratory of Architecture and Computation II

Fabricació Digital
Digital Fabrication

ETSAB 22-23
2on Quadrimestre

Sonalls del Silenci



#equip

LACii | Laboratori d'Arquitectura Computacional II
LACii | Laboratory of Architecture and Computation II

Fabricació Digital
Digital Fabrication

ETSAB 22-23
2on Quadrimestre



LAC ii | Laboratori d'Arquitectura Computacional II
LAC ii | *Laboratory of Architecture and Computation II*

#publicació



ETSAB 22-23
2on Quadrimestre

Fabricació Digital
Digital Fabrication



#crit

LAC ii | Laboratori d'Arquitectura Computacional II
LAC iii | Laboratory of Architecture and Computation II

Fabricació Digital
Digital Fabrication
ETSAB 22-23
2on Quadrimestre

#lecture

LAC ii | Laboratori d'Arquitectura Computacional II
LAC ii | Laboratory of Architecture and Computation II

Fabricated Digital
Physical Fabrication

ETSAB 22-23
2on Quadrimestre



LAC i | Laboratori d'Arquitectura Computacional I
LAC ii | Laboratori d'Arquitectura Computacional II



ETSAB 22-23
1er – 2on Quadrimstre

Disseny Computacional
Fabricació Digital